

High Voltage Bushings

quality ceramic-to-metal seals for reliable products



MACOR Machining China Inc. is a global materials engineering company which designs and manufactures a wide range of high specification products with extraordinary properties, across multiple sectors and geographies.

From an extensive range of advanced materials we produce components, assemblies and systems that deliver significantly enhanced performance for our customers' products and processes. Our engineered solutions are produced to very high tolerances and many are designed for use in extreme environments.

The Company thrives on breakthrough innovation. Our materials scientists and applications engineers work in close collaboration with customers to create outstanding, highly differentiated products that perform more efficiently, more reliably and for longer.

Morgan Advanced Materials has a global presence with more than 10,000 employees across 50 countries serving specialist markets in the energy, transport, healthcare, electronics, security and defence, petrochemical and industrial sectors. It is listed on the London Stock Exchange in the engineering sector (ticker MGAM).

Morgan Advanced Materials is a world leader in the field of ceramic to metal sealing and assembly manufacture.

- 55,000 square foot facility in New Bedford, Massachusetts
- Part of the Morgan group of businesses since 1989
- Facility has significantly expanded its manufacturing capabilities
- Provides technically superior engineered products for challenging environments
- Ceramics, metals and braze alloys are utilized in production processes
- Predominant ceramics are the Aluminas with minimum 95% Al_2O_3 content
- A range braze alloys are used to ensure an effective hermetic seal
- Tungsten, nickel, copper and platinum are available for components

Morgan utilizes these materials within a set of integrated production processes, which can call upon 100% materials traceability so any product lifetime is mapped out from sourcing the materials through preparation, manufacture and final product implementation. This unique position, to control every aspect of creating ceramic to metal assemblies, from design and development, to sourcing and production means that Morgan are ideally placed to provide bespoke products in line with specific client requirements.

TECHNICAL DATA

Standard Bushing, Materials, Finishes

Insulators- A-950 High Alumina Ceramic (see table).

Glaze- High temperature- for cleanliness, appearance and high surface resistivity.

Soft caps & flanges- 42% nickel-iron with fused silver or equivalent finish suitable for soldering- specify if high temperature brazing or welding.

Studs- Low carbon steel, nickel plated or Grade R-405 Monel unplated.

Braze material- silver-copper eutectic (melting Temp. 779°C) or higher temperature material.

Modifications Frequently Made On Standard Bushings

Special metal parts for severe environmental conditions or non-magnetic requirements, such as monel, copper, stainless steel or other.

The special design of studs, terminal, lugs or turrets.

Special finishes, such as copper, nickel, tin or gold plating.

Addition of center conductors of specified material.

Special flange designs for heliarc welding.

Additional terminals (four or more) on F-17 and F-22 series bushings.

Brazed or welded mounting adaptors to customer-supplied of Alberox-supplied flanges for multiple headers.

Brazing with special braze materials such as copper, copper-gold, nickel-gold or other alloys.

Note: Bushings are 100% mass spectrometer leak tested with helium. All dimensions and designs are subject to change without notice.

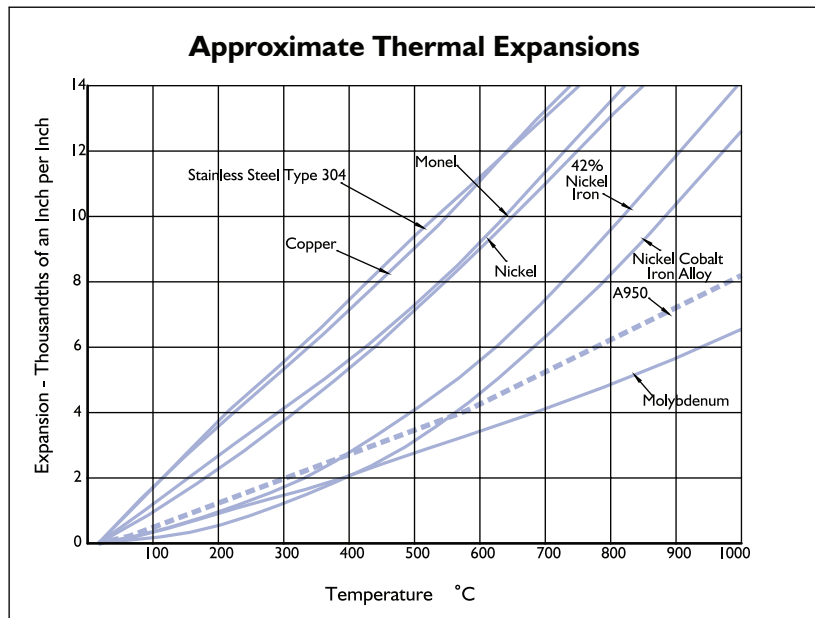

A-950 HIGH ALUMINA CERAMIC

Mechanical and Electrical Properties

Property	Units	Value	Notes
Alumina content	%	95	
Color		White	
Government designation		L625C	MIL-I-10B
Specific gravity	g/cc	3.73	
Water absorption		Impervious	Dye penetrant
Impenetrability	atm cc/sec He	1×10^{-13}	Mass spectrometer
Tensile strength	PSI	31,000	
Compressive strength	PSI	385,000	
Transverse strength	PSI	51,000	
Elastic modulus	PSI	47×10^6	Young's
Hardness		9	Moh's scale
Impact strength	ft-lbs	7.5	Charpy
Specific heat	Cal/gm/°C	0.19	
Thermal conductivity	W/m•°K	21	
Maximum working temp.	°F	2900	
Coefficient of thermal expansion	°C	8.0×10^{-6}	25-1000°
Dielectric strength	Volts AC/mil	225 320	25°C, 60 CPS 1/4" thick specimen 1/8" thick specimen
Dielectric constant		9.27 ; 9.17	1 MHz ; 10 MHz
Dielectric loss tangent		0.0003 ; 0.0006	1 MHz ; 10 MHz
Volume resistivity	Ohm-cm	$>10^{14}$; $>10^9$	at 25°C ; at 500°C

High Voltage Fluted Bushings

Single Terminal

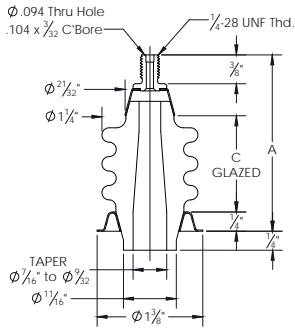

IF-10

Part No.	No. of Flutes	A	C	Average Flash-over (KV)*	Approx. Net Weight
IF-10-7-2	2	1 ^{29/32}	7/8	20	2 oz
IF-10-10-2	3	2 ^{9/32}	1 1/4	24	3 oz
IF-10-13-2	4	2 ^{21/32}	1 5/8	28	4 oz

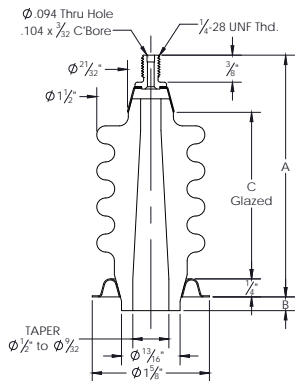

IF-12

Part No.	No. of Flutes	A	B	C	Average Flash-over (KV)*	Approx. Net Weight
IF-12-10-2	2	2 ^{9/32}	1/4	1 1/4	25	4 oz
IF-12-14-2	3	2 ^{25/32}	1/4	1 3/4	30	5 oz
IF-12-18-2	4	3 ^{9/32}	1/4	2 1/4	35	6 oz
IF-12-22-2	5	3 ^{25/32}	1/4	2 3/4	40	7 1/2 oz
IF-12-22-8	5	3 ^{25/32}	1	2 3/4	40	8 oz

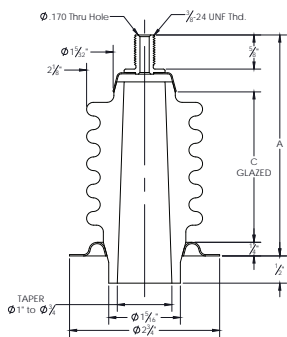

IF-17

Part No.	No. of Flutes	A	C	Average Flash-over (KV)*	Approx. Net Weight
IF-17-10-4	2	2 ^{9/16}	1 1/4	25	6 oz
IF-17-14-4	3	3 ^{1/16}	1 3/4	30	8 oz
IF-17-18-4	4	3 ^{9/16}	2 1/4	35	10 oz
IF-17-22-4	5	4 ^{1/16}	2 3/4	40	12 oz

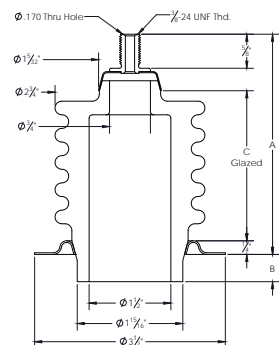

IF-22

Part No.	No. of Flutes	A	B	C	Average Flash-over (KV)*	Approx. Net Weight
IF-22-14-4	3	3 ^{1/16}	1/2	1 3/4	31	13 oz
IF-22-18-4	4	3 ^{9/16}	1/2	2 1/4	36	1 lb
IF-22-22-4	5	4 ^{1/16}	1/2	2 3/4	41	1 1/4 lb
IF-22-26-8	6	4 ^{9/16}	1	3 1/4	45	1 1/2 lb
IF-22-34-10	8	5 ^{9/16}	1 1/4	4 1/4	50	2 lb

*Flashover ratings are average a-c values at 60 cycles RMS, 40% relative humidity at sea level

High Voltage Fluted Bushings

Two Terminals

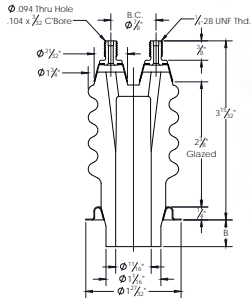

2F-14

Part No.	No. of Flutes	B	Average Flashover (KV)*	Approx. Net Weight
2F-14-19-4	4	1/2	36	9 oz
2F-14-19-10	4	1 1/4	36	9 1/2 oz

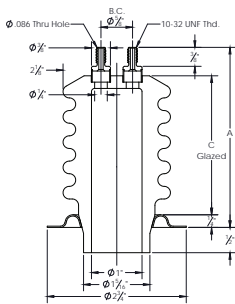

2F-17

Part No.	No. of Flutes	A	C	Average Flashover (KV)*	Approx. Net Weight
2F-17-10-4	2	2 1/16	1 1/4	25	6 oz
2F-17-14-4	3	2 9/16	1 3/4	30	8 oz
2F-17-18-4	4	3 1/16	2 1/4	35	10 oz
2F-17-22-4	5	3 9/16	2 3/4	40	12 oz

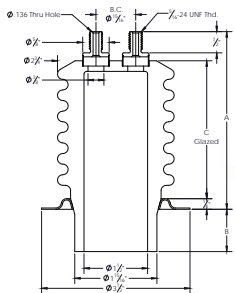

2F-22

Part No.	No. of Flutes	A	B	C	Average Flashover (KV)*	Approx. Net Weight
2F-22-10-4	2	2 3/16	1/2	1 1/4	26	10 oz
2F-22-14-4	3	2 11/16	1/2	1 3/4	31	13 oz
2F-22-18-4	4	3 3/16	1/2	2 1/4	36	1 lb
2F-22-22-4	5	3 11/16	1/2	2 3/4	41	1 1/4 lb
2F-22-26-8	6	4 3/16	1	3 1/4	45	1 1/2 lb
2F-22-34-10	8	5 3/16	1 1/4	4 1/4	50	2 lb

*Flashover ratings are average a-c values at 60 cycles RMS, 40% relative humidity at sea level

High Voltage Fluted Bushings

Three Terminals

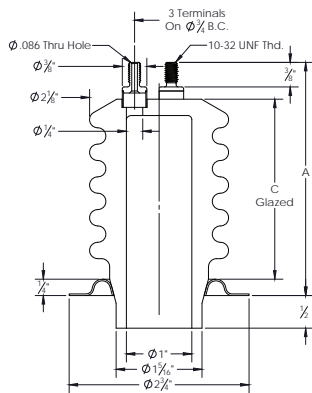

3F-17

Part No.	No. of Flutes	A	C	Average Flash-over (KV)*	Approx. Net Weight
3F-17-10-4	2	2 ^{1/16}	1 ^{1/4}	25	6 oz
3F-17-14-4	3	2 ^{9/16}	1 ^{3/4}	30	8 oz
3F-17-18-4	4	3 ^{1/16}	2 ^{1/4}	35	10 oz
3F-17-22-4	5	3 ^{9/16}	2 ^{3/4}	40	12 oz

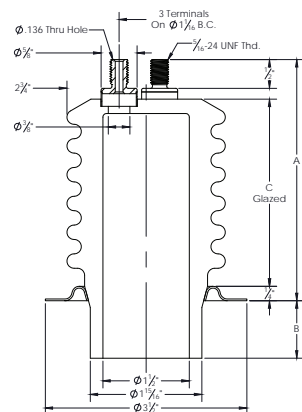

3F-22

Part No.	No. of Flutes	A	B	C	Average Flash-over (KV)*	Approx. Net Weight
3F-22-10-4	2	2 ^{3/16}	1/2	1 ^{1/4}	26	10 oz
3F-22-14-4	3	2 ^{11/16}	1/2	1 ^{3/4}	31	13 oz
3F-22-18-4	4	3 ^{3/16}	1/2	2 ^{1/4}	36	1 lb
3F-22-22-4	5	3 ^{11/16}	1/2	2 ^{3/4}	41	1 ^{1/4} lb
3F-22-26-8	6	4 ^{3/16}	1	3 ^{1/4}	45	1 ^{1/2} lb
3F-22-34-10	8	5 ^{3/16}	1 ^{1/4}	4 ^{1/4}	50	2 lb

*Flashover ratings are average a-c values at 60 cycles RMS, 40% relative humidity at sea level

High Voltage Re-entrant Bushings

Re-entrant skirt bushings achieve higher voltage ratings compared with bushings of comparable height, because of the increased strike distance from stud to flange.

Easy potting of insulated high-voltage leads with silicone, epoxy or other compounds is possible because of the design of the re-entrant skirt. Complete insulation from leads to ceramic is provided by potting to improve corona start level at the leads.

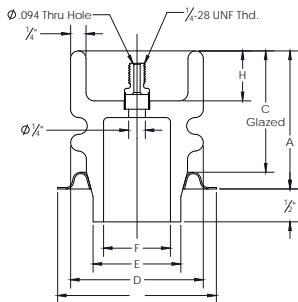

IR-17 IR-22

Part No.	A	C	D Dia.	E Dia.	F Dia.	G Dia.	H	Average Flashover (KV)*	Approx. Net Weight
IR-17-14-4	2	1 3/4	2c	1 5/16	1	2 3/8	3/4	33	7 oz
IR-22-22-4	3	2 3/4	2 3/4	1 5/16	1 1/2	3 1/2	1	44	13 oz

2R-17 2R-22

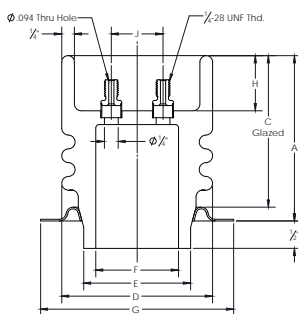

Part No.	A	C	D Dia.	E Dia.	F Dia.	G Dia.	H	J	Average Flashover (KV)*	Approx. Net Weight
2R-17-14-4	2	1 3/4	2c	1 5/16	1	2 3/8	3/4	5/8	32	7 1/2 oz
2R-22-22-4	3	2 3/4	2 3/4	1 5/16	1 1/2	3 1/2	1	15/16	43	13 1/2 oz

*Flashover ratings are average a-c values at 60 cycles RMS, 40% relative humidity at sea level

Cable Terminations

CT Type

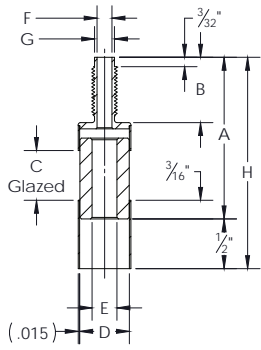

Part No.	A	B	C	D Dia.	E Dia.	F Dia.	G Dia.	H	Thd. Size	Approx. Net Weight
CT-250	1 3/16	13/32	5/16	.250	1/8	.082	.125	1 11/16	8-32	1/8 oz
CT-320	1 3/16	13/32	5/16	.320	5/32	.117	.148	1 11/16	10-32	1/8 oz
CT-330	1 3/8	13/32	1/2	.330	5/32	.117	.148	1 7/8	10-32	1/8 oz
CT-375	1 3/8	13/32	1/2	.375	3/16	.117	.148	1 7/8	10-32	1/8 oz
CT-450	1 5/8	21/32	1/2	.450	1/4	.150	.203	2 1/8	1/4 -28	1/2 oz
CT-500	1 5/8	21/32	1/2	.500	1/4	.150	.203	2 1/8	1/4 -28	1/2 oz

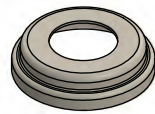
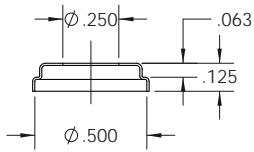

CAP H-32 LUG

All T-32 units shown can be furnished with lug, or plain cap H-32 as shown. On T-24, T-48 and T-64 units consult factory.

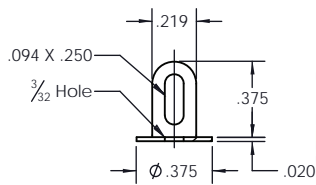

*Flashover ratings are average a-c values at 60 cycles RMS, 40% relative humidity at sea level

Tubular Bushings

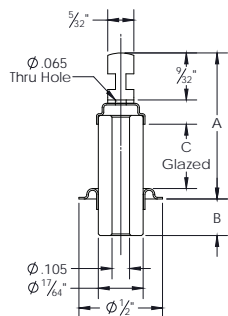

T-17

Part No.	A	B	C	Average Flash-over (KV)*	Approx. Net Weight
T-17-14-6	3/4	3/32	7/32	6.6	1/8 oz
T-17-14-4	3/4	7/32	7/32	6.6	1/8 oz
*T-17-18-6	13/16	3/32	9/32	7.6	1/8 oz
*T-17-22-6	7/8	3/32	11/32	8.6	1/8 oz
*T-17-22-14	7/8	7/32	11/32	8.6	1/8 oz

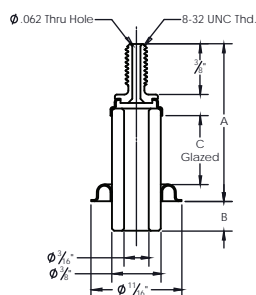

T-24

Part No.	A	B	C	Average Flash-over (KV)*	Approx. Net Weight
T-24-12-2	27/32	1/32	3/16	6.4	1/8 oz
T-24-24-2	11/32	1/32	3/8	9.0	1/8 oz
T-24-32-2	15/32	1/32	1/2	10.8	1/8 oz
T-24-32-6	15/32	3/32	1/2	10.8	1/8 oz
T-24-32-14	15/32	7/32	1/2	10.8	1/4 oz
T-24-40-2	19/32	1/32	5/8	12.6	1/4 oz
T-24-40-6	19/32	3/32	5/8	12.6	1/4 oz
T-24-40-14	19/32	7/32	5/8	12.6	1/4 oz

T-48

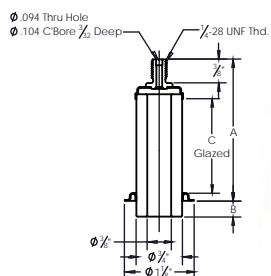

Part No.	A	B	C	Average Flash-over (KV)*	Approx. Net Weight
T-48-35-8	19/64	C	35/64	11.4	1 oz
T-48-64-16	13/4	1/4	1	18.0	1 oz
T-48-84-16	21/16	1/4	15/16	21.5	1 1/2 oz
T-48-92-16	23/16	1/4	17/16	22.5	1 1/2 oz
T-48-128-16	23/4	1/4	2	27.0	2 oz
T-48-164-16	35/16	1/4	29/16	32.0	2 1/4 oz
T-48-184-24	35/8	3/8	27/8	35.0	2 3/4 oz

*Flashover ratings are average a-c values at 60 cycles RMS, 40% relative humidity at sea level

Tubular Bushings

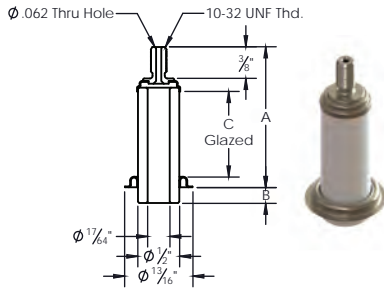

T-32

Part No.	A	B	C	Average Flash-over (KV)*	Approx. Net Weight
T-32-12-2	53/64	1/32	3/16	6.4	¼ oz
T-32-19-2	15/16	1/32	19/64	8.0	¼ oz
T-32-23-6	1	3/32	23/64	8.8	¼ oz
T-32-25-2	1 1/32	1/32	25/64	9.2	¼ oz
T-32-31-2	1 1/8	1/32	31/64	10.6	¼ oz
T-32-32-6	1 9/64	3/32	½	10.8	¼ oz
T-32-38-2	1 15/64	1/32	19/32	12.2	½ oz
T-32-39-6	1 ¼	3/32	39/64	12.4	½ oz
T-32-39-16	1 ¼	¼	39/64	12.4	½ oz
T-32-44-2	1 21/64	1/32	11/16	13.6	½ oz
T-32-46-12	1 23/64	3/16	23/32	14.0	½ oz
T-32-56-12	1 33/64	3/16	7/8	16.4	½ oz
T-32-58-2	1 17/32	1/32	29/32	16.8	½ oz
T-32-64-12	1 41/64	3/16	1	18.0	½ oz
T-32-70-2	1 47/64	1/32	1 3/32	19.4	½ oz
T-32-89-8	2 1/32	1/8	1 25/64	21.4	¾ oz
T-32-91-20	2 1/16	5/16	1 27/64	21.6	¾ oz
T-32-96-20	2 9/64	5/16	1 ½	22.2	¾ oz
T-32-108-16	2 23/64	¼	1 11/16	23.4	¾ oz
T-32-112-20	2 25/64	5/16	1 ¾	24.0	¾ oz
T-32-134-16	2 47/64	¼	2 3/32	26.4	1 oz
T-32-153-22	3 1/32	11/32	2 25/64	28.8	1 1/8 oz

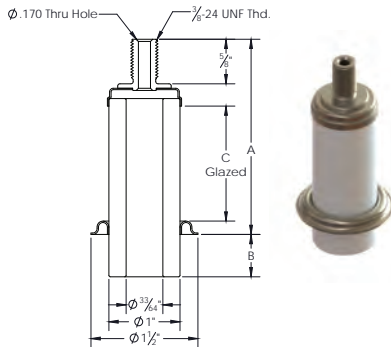

T-64

Part No.	A	B	C	Average Flash-over (KV)*	Approx. Net Weight
T-64-36-4	1 11/16	1/16	9/16	11.6	2 oz
T-64-70-18	2 7/32	9/32	1 3/32	19.4	2 ½ oz
T-64-102-38	2 23/32	19/32	1 19/32	20.4	3 ¼ oz
T-64-134-58	3 7/32	29/32	2 3/32	28.0	4 ½ oz
T-64-208-64	4 3/8	1	3 ¼	37.5	6 oz
T-64-272-64	5 3/8	1	4 ¼	45.0	7 ½ oz

NOTE: On terminal bushings with voltage ratings of 20 KV and over, it is recommended that an insulated lead be used inside the ceramic.

High Current Bushings

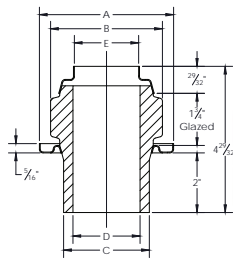

HC Type

Part No.	A	B	C	D	E	Center Cond. Dia.	Approx. Net Weight
HC-17	2.750	2 ^{1/8}	1 ^{1/4}	1	.906	3/4	1 lb
HC-26	4.000	3 ^{1/4}	2 ^{3/8}	1 ^{3/4}	1.719	1 ^{1/2}	2 lbs
HC-30	4.500	3 ^{3/4}	2 ^{7/8}	2 ^{1/4}	2.156	2	3 lbs

Low Profile Bushings

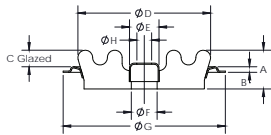

LP Type

Part No.	A	B	C	D	E	F	G	H	Average Flash-over (KV)*	Approx. Net Weight
LP-6	5/16	5/64	9/64	3/4	5/16	19/64	1.00	.196	8.6	1/2 oz
LP-13	3/8	11/64	3/16	15/8	25/64	23/64	1.906	.196	16.0	1 oz
LP-18	21/32	5/32	9/32	2 ^{1/4}	1/2	7/16	2.750	.250	21.0	4 oz
LP-36	1 ^{1/16}	3/4	19/64	4 ^{1/2}	3/4	3/4	5.500	.505	35.0	1 ^{3/4} lbs

Barrel Bushings

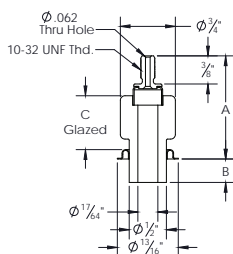

B-48

Part No.	A	B	C	Average Flash-over (KV)*	Approx. Net Weight
B-48-28-12	15/32	3/16	7/16	12.4	3/4 oz
B-48-44-20	13/32	5/16	11/16	16.0	1 oz

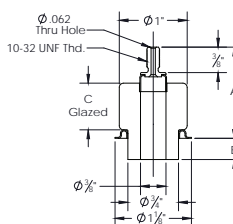

B-64

Part No.	A	B	C	Average Flash-over (KV)*	Approx. Net Weight
B-64-28-12	15/32	3/16	7/16	14.0	1 oz
B-64-44-20	13/32	5/16	11/16	17.8	1 ^{1/4} oz

*Flashover ratings are average a-c values at 60 cycles RMS, 40% relative humidity at sea level

